

TAPERED THERMOWELL

STANDARD 0.260" BORE

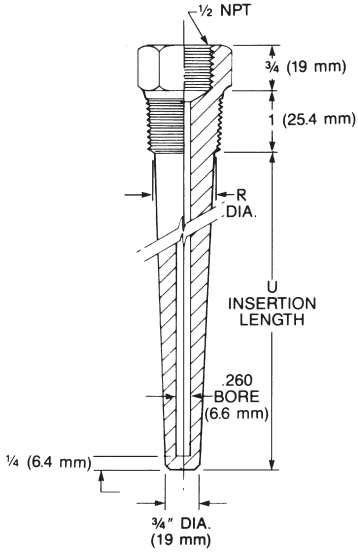

TO ORDER:

S24 - - - (U) Inches

Code	Process Connection	"R"
3/4	3/4" NPT	7/8"
1	1" NPT	1 1/16"

Code	Material
304	304/L SS
316	316/L SS
()	Other Specify

Optional plug and chain available on request.

LAGGING EXTENSION 0.260" BORE

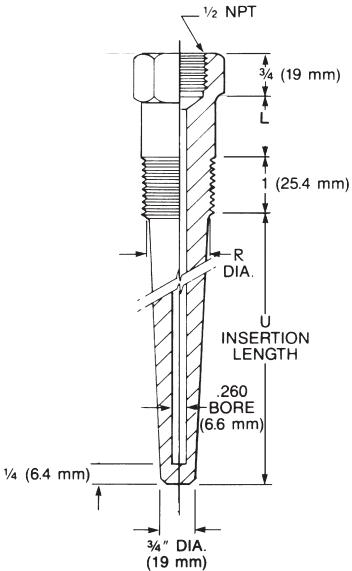

TO ORDER:

SL24 - - - - (L) Inches (U) Inches

Code	Process Connection	"R"
3/4	3/4" NPT	7/8"
1	1" NPT	1 1/16"

Code	Material
304	304/L SS
316	316/L SS
()	Other Specify

Optional plug and chain available on request.